

Automatic burner control unit IFD 244, IFD 258

OPERATING INSTRUCTIONS

Cert. Version 02.18 · Edition 09.19 · EN · 03250729



SAFETY

Please read and keep in a safe place



Please read through these instructions carefully before installing or operating. Following the installation, pass the instructions on to the operator. This unit must be installed and commissioned in accordance with the regulations and standards in force. These instructions can also be found at www.docuthek.com.

Explanation of symbols

1, 2, 3, a, b, c = Action

→ = Instruction

Liability

We will not be held liable for damage resulting from non-observance of the instructions and non-compliant use.

Safety instructions

Information that is relevant for safety is indicated in the instructions as follows:

⚠ DANGER

Indicates potentially fatal situations.

⚠ WARNING

Indicates possible danger to life and limb.

⚠ CAUTION

Indicates possible material damage.

All interventions may only be carried out by qualified gas technicians. Electrical interventions may only be carried out by qualified electricians.

Conversion, spare parts

All technical changes are prohibited. Only use OEM spare parts.

CHECKING THE USAGE

IFD 244/IFD 258

For atmospheric burners or forced draught burners used in multiple burner applications, where a central control system is used for pre-purge and for monitoring the limits. For direct ignition and monitoring of gas burners in continuous operation. Suitable for intermittent operation thanks to its fast reaction to different

CONTENTS

Safety	1
Checking the usage	1
Installation	2
Replacing the automatic burner control unit IFS	3
Cable selection	3
Cable installation	4
Wiring	4
Commissioning	5
Checking the function	6
System maintenance instructions	7
Assistance in the event of malfunction	7
Reading off the flame signal and the parameters	10
Technical data	10
Logistics	11
Certification	11

process requirements. 2-digit 7-segment display for indicating program status and flame signal intensity.

IFD..I

With integrated ignition.

⚠ WARNING

- The user must ensure that the high-voltage output (IFD..I) is protected against accidental contact.
- The IFD..I may not be used for domestic, commercial and trade, or small firm application due to emitted electromagnetic interference.

IFD 244

Gas burner monitoring with a flame rod. For grounded mains. With restart after a flame failure.

IFD 258

Gas burner monitoring with a flame rod or a UV sensor. In the case of UV control with UV sensors of Type UVS, the IFD may be used for intermittent operation only. This means that operation must be interrupted once within 24 hours.

Ionization control is possible in both grounded and ungrounded systems.

Ignition and monitoring with a single electrode is possible (single-electrode operation).

The cut-off point can be set using a potentiometer. The behaviour in the event of flame failure during operation can be selected using a switch. Either an immediate fault lock-out or an automatic restart occurs.

→ Mains voltage, ambient temperature, safety time, enclosure, and with IFD..I also the ignition voltage (peak-peak) and ignition current – see type label.

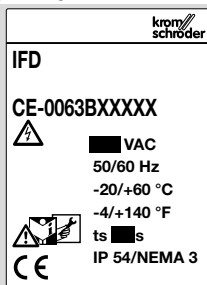

→ No condensation permitted on the PC boards (enclosure IP 54).

→ Length of sensor cable:
ionization control: max. 75 m,
UV control: max. 100 m.

→ In the event of an automatic restart, the program sequence started must match the application and the burner must be able to restart as intended in all operating phases.

Type code

IFD	Automatic burner control unit for continuous operation
2	Series 200
4	Ionization control
5	ionization or UV control

4	Restart in the event of flame failure
8	Immediate fault lock-out or restart, switchable
-3	Safety time on start-up: 3 s
-5	Safety time on start-up: 5 s
-10	Safety time on start-up: 10 s
/1	Safety time during operation: 1 s
W	Mains voltage: 230 V AC, 50/60 Hz
Q	Mains voltage: 120 V AC, 50/60 Hz
Y	Mains voltage: 200 V AC, 50/60 Hz
P	Mains voltage: 100 V AC, 50/60 Hz
I	Integrated electronic ignition

Part designations

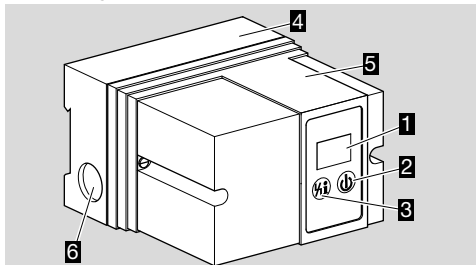

- 1 LED display for program status and fault messages
- 2 On/Off button
- 3 Reset/Information button
- 4 Lower housing section
- 5 Upper housing section
- 6 Knock-out hole for M16 cable gland

INSTALLATION

⚠ CAUTION

- Dropping the device can cause permanent damage. In this event, replace the entire device and associated modules before use.
- Installation position as required.
- Eight knock-out holes are pre-prepared for wiring, M16 plastic cable gland for 8 to 10 mm cable diameter.

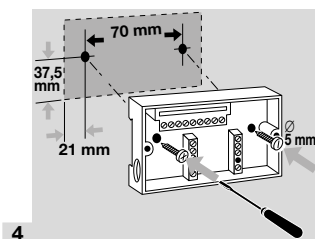
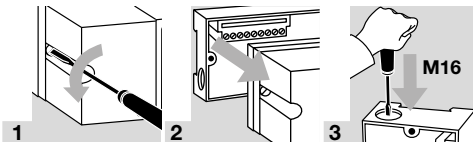

REPLACING THE AUTOMATIC BURNER CONTROL UNIT IFS

CAUTION

- Dropping the device can cause permanent damage. In this event, replace the entire device and associated modules before use.
- Installation position as required.
- The housing dimensions and the hole pattern have not changed.
- The new upper section of the housing will fit on the existing lower section.
- The electrical connection is unchanged.
- Replacement possibilities:

Old unit	New unit
IFS 244	IFD 244
IFS 258	IFD 258

CAUTION

- Only use the specified variants, when replacing the automatic burner control units IFS 244 or IFS 258.

Changes in comparison with the IFS:

- The IFD has a 7-segment display for indicating flame signal intensity, operating state and flame simulation.
- With the IFD, the fault signal occurs when mains voltage is supplied.
- The IFD is additionally equipped with the following protection functions:
- against over-frequent switching off during the safety time on start-up, against over-frequent remote resets and against over-frequent cycling. The cycle lock is dependent on the safety time on start-up and the ignition device.

t_{SA} [s]	t_z [s]	Type of ignition	Cycle lock [s]
3	1.8	TZI	10
5	3	TZI	12
10	6	TZI	15
3	1.8	IFD..I	36
5	3	IFD..I	60
10	6	IFD..I	120

- In the event of a short-circuit on the valve output, return the unit to the manufacturer.
- Max. number of operating cycles: 250,000.
- Mains voltage: IFD 244: 120, 230 V.
IFD 258: 100, 120, 200, 230 V.

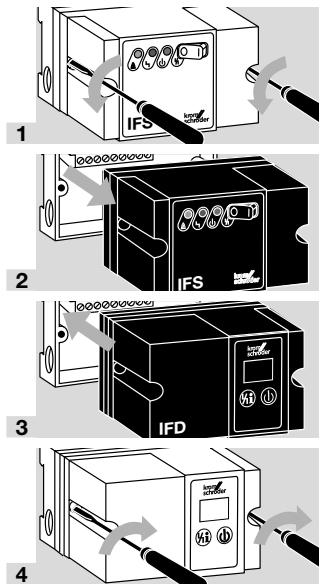

CABLE SELECTION

- Use mains cable suitable for the type of operation and complying with local regulations.
- Signal and control line: max. 2.5 mm².
- Cable for burner ground/PE wire: 4 mm².
- For the ionization and ignition cables, use unscreened high-voltage cable: FZLSi 1/7 up to 180°C, Order No. 04250410, or FZLk 1/7 up to 80°C, Order No. 04250409.

A = Ionization cable

- Max. 75 m.

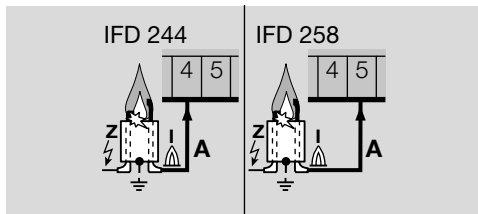

B = Ignition cable

- Max. 5 m, recommended 1 m.
- IFD..I: max. 1 m, recommended 0.7 m.

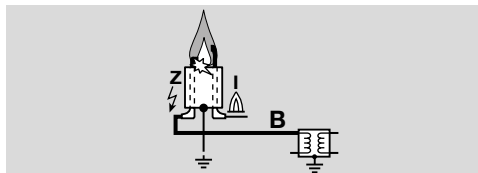

IFD 258

C = UV cable

- Max. 100 m.

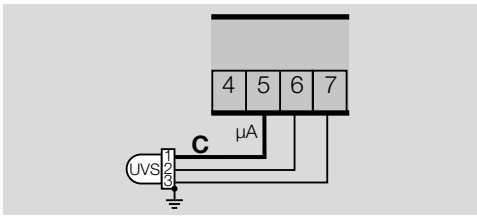

CABLE INSTALLATION

Reduction of EMC

- External electrical interference must be avoided.
- Lay cables individually and, if possible, not in a metal conduit.
- Do not lay UV/ionization cable and ignition cable together and lay them as far apart as possible.
- Screw the ignition cable securely into the ignition device and run to the burner by the shortest possible route.
- Only use radio interference suppressed spark plugs with a resistance of 1 kΩ.

WIRING

Legend

	Safety interlocks (limits)
	Start-up signal
	Ignition transformer
	Gas valve
	Fault signal
	Operating signal
	Reset
	Safety circuit

- 1** Disconnect the system from the electrical power supply.
- Use the pre-prepared knock-out holes for wiring.
- 2** Use M16 or PG 11 plastic cable gland for 5 to 10 mm cable diameter.

CAUTION

- Make a good PE (ground) wire connection to the automatic burner control unit and burner, otherwise the appliance may be damaged when used in single-electrode operation.

WARNING

- Ensure that voltage outputs and inputs have the same polarity and are not reversed.
- Connection only with permanent wiring.
- Do not reverse L1, N and PE.
- Do not set the reset function so that it operates automatically in cycles.

- 3** Wire the automatic burner control unit as shown in the connection diagram.

Connection diagrams

→ The operation and fault signalling contacts do not meet the requirements for safety extra-low voltage (SELV/PELV).

- A** = Ionization control
- B** = Single-electrode operation
- C** = UV control

IFD 244/IFD 244..I

→ Fault signalling contact (terminals 7/8): max. 2 A, 253 V, not fused internally.

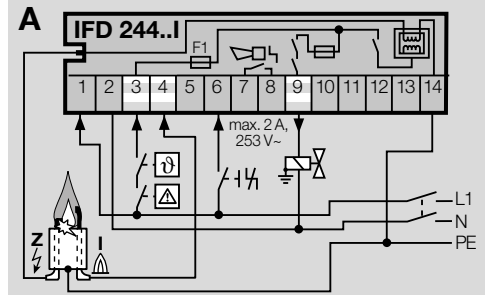
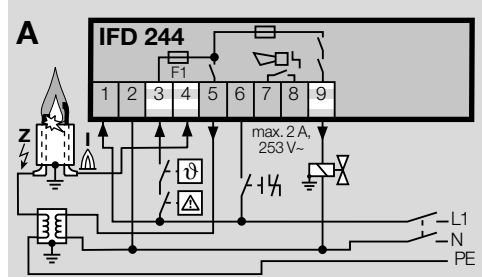

IFD 258

- Use the Elster Kromschroder ignition transformer TZI/TGI in single-electrode operation
- B**. Connect burner ground to the IFD via terminal 7, otherwise the IFD will be damaged.
- Use the Elster Kromschroder UV sensor UVS for UV control **C**.

WARNING

- For UV control, the IFD 258 must be permanently supplied with voltage. Do not switch on the IFD power supply synchronously with the heat demand.
- Operation signalling contact (terminals 13/14) and fault signalling contact (terminals 8/9): max. 2 A, 253 V, not fused internally.
- Terminals 11 and 12 are connected internally.

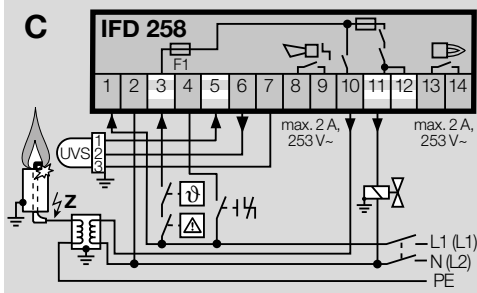
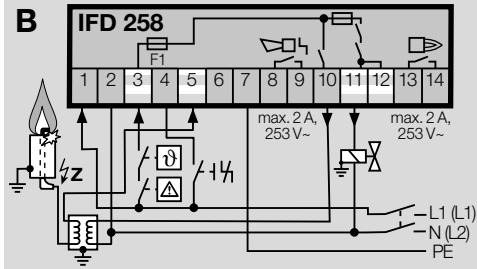
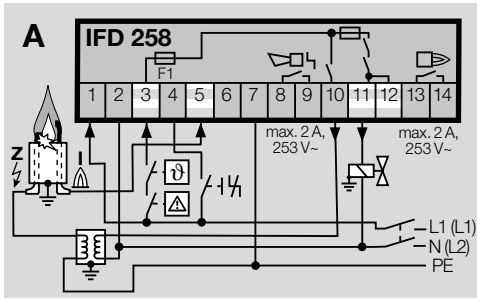

IFD 258..I

- Single-electrode operation is not possible.
- Use the Elster Kromschroder UV sensor UVS for UV control **C**.

⚠ WARNING

- For UV control, the IFD 258 must be permanently supplied with voltage. Do not switch on the IFD power supply synchronously with the heat demand.
- Operation signalling contact (terminals 13/14) and fault signalling contact (terminals 8/9): max. 2 A, 253 V, not fused internally.

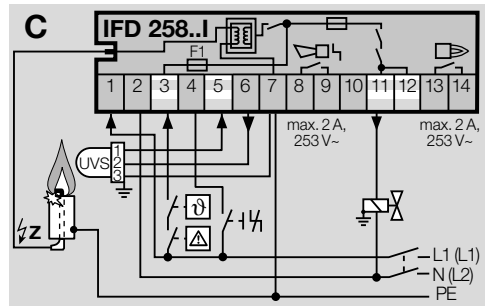
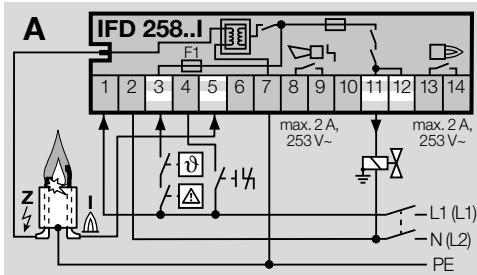

IFD 244..I, IFD 258..I

- Screw the ignition cable securely approx. 5 cm into the IFD..I onto a screw.

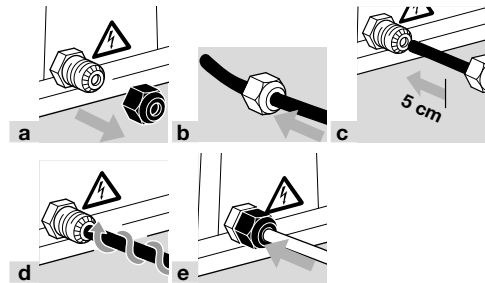

- 4 Replace the upper section and tighten.

COMMISSIONING

- During operation, the 7-segment display shows the program status:

00	Start-up position
01	Waiting time
02	Safety time on start-up
04	Operation

⚠ DANGER

- Check the system for tightness before commissioning.

- 1 Close the manual valve!
- 2 Switch on the system.
- 3 Apply voltage to terminal 1.
- 4 Check the electrical installation.
- 5 Switch on the IFD.

- The display indicates 00.

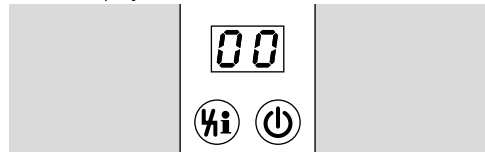

- The IFD retains its switch position when the voltage is removed from terminal 1.

- 6 Start the program for the burner: apply voltage to terminal 3 – the display indicates 01.



⚠ WARNING

– The unit is defective if it opens a gas valve during the waiting time (display 01). Remove the unit and return it to the manufacturer.

→ ϑ signal minimum ON time (terminal 3):

IFD..-3: 8 s

IFD..-5: 10 s

IFD..-10: 15 s

The times must be at least this long, otherwise the automatic burner control unit cannot monitor the burner.

→ Gas valve V1 opens, the burner ignites and the display indicates 02.



→ Ignition time t_z :

IFD..-3: 2 s

IFD..-5: 3 s

IFD..-10: 6 s

→ After the safety time t_{SA} (3, 5 or 10 s) has elapsed, the IFD signals a fault. The display indicates a blinking 02.



7 Open the gas cock.

8 Reset the IFD by pressing the Reset/Information button.

9 Start the program for the burner: apply voltage to terminal 3.

→ The display indicates 02, the gas valve V1 opens and the burner ignites.



→ After the safety time t_{SA} (3, 5 or 10 s) has elapsed, the display indicates 04.



→ IFD 258: the contact between terminals 13 and 14 closes.



→ The burner is in operation.

Adjustment

IFD 258:

1 Undo the screws and remove the upper section.

Behaviour in the event of flame failure

2 Set the switch to the desired position (Immediate fault lock-out  or Restart .

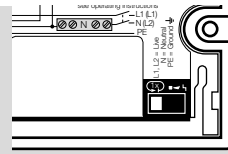

→ At the factory, the IFD 258 is set to Immediate fault lock-out.

→ Restart is recommended for burners which occasionally display unstable flame behaviour. Do not use with slow-closing air control valves or continuous control, if the burner must not be ignited at max. capacity, for burners with an output of over 120 kW in accordance with EN 676.

Cut-off sensitivity

→ The cut-off point can be adjusted between 2 and 20 μ A (set at the factory to 2 μ A).

3 Increase the set value using the potentiometer, when the display blinks and indicates 01 before ignition.

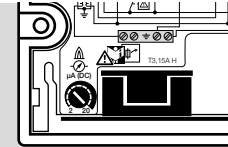

4 Screw the upper section back on.

CHECKING THE FUNCTION

1 During operation with two electrodes or UV control, disconnect the spark plug from the flame rod or black out the UV sensor. IFD 258: in single-electrode operation, close the manual valve.

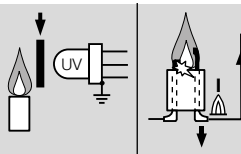

⚠ WARNING

Danger of death!

– If the IFD 258 is used in single-electrode operation, high voltage is supplied to the spark plug upon restart.

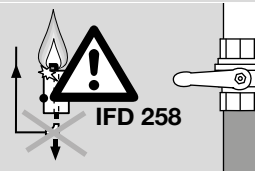

→ IFD 244: the IFD 244 generates a restart and subsequently a fault lock-out. IFD 258: if the switch is set to Restart, the IFD 258 first restarts, and then performs a fault lock-out. A fault lock-out involves disconnecting the power

from the gas valves. The fault signalling contact between the terminals (IFD 258: **8** and **9**, IFD 244: **7** and **8**) closes. The display blinks and displays the current program status.

- The flame must go out.
- If the flame does not go out, there is a fault.
- 2** Check the wiring – see page 4 (Wiring).

⚠ WARNING

- The fault must be remedied before the system may be operated without supervision.

SYSTEM MAINTENANCE INSTRUCTIONS

- The On/Off button on the IFD separates the IFD functionally from the mains. It does not fulfil the requirements for a device to disconnect the electrical equipment.
- For maintenance work on the system, isolate the electrical equipment from the voltage supply and lock it to prevent it being switched on again.

ASSISTANCE IN THE EVENT OF MALFUNCTION

⚠ WARNING

Electric shocks can be fatal!

- Before working on possible live components, ensure the unit is disconnected from the power supply.
- Fault-clearance must only be undertaken by authorized trained personnel!
- Do not carry out repairs on the IFD on your own as this will cancel our guarantee! Unauthorized repairs or incorrect electrical connections, e.g. the connection of power to outputs, can cause the gas valve to open and the IFD to become defective. In this case, fail-safe operation can no longer be guaranteed.
- (Remote) resets may only be conducted by authorized trained personnel with continuous monitoring of the burner to be reset.
- If the system suffers a fault, the automatic burner control unit will close the gas valves, the display will blink and show the current program status.
 - Faults may be cleared only using the measures described below –
 - Reset and the IFD will restart –
- The IFD can only be reset when the display is blinking, not when the flame signal or a parameter is being displayed. In this case press the Reset/Information button until the display starts to blink or switch the unit off and on again. The IFD can now be reset.
- If the IFD does not react despite the faults having been rectified –

- Remove the unit and return it to the manufacturer for inspection.

Assistance in the event of malfunction

? Fault

! Cause

- **Remedy**



? The display blinks and indicates 01?

- ! The IFD has detected an incorrect flame signal without the burner having been ignited (extraneous signal) –

- ! Flame signal through ceramic insulation –

IFD 258:

- ! The UV tube in the UV sensor UVS is defective (service life ended) and permanently indicates an extraneous signal.

- Exchange UV tube, Order No.: 04065304 – note the Operating instructions for UV sensor UVS.
- Increase value of parameter 04 in order to adapt the switch-off threshold of the flame amplifier.



? Start-up – no gas supply – the display blinks and indicates 02?

- ! The gas valve does not open –
- Check voltage supply to the gas valve.
- After a short-circuit on the valve output, the internal fuse in the unit tripped. The fuse cannot be replaced. Return the unit to the manufacturer for inspection.

- ! There is still air in the pipeline, for example after installation work or if the system has not been used for a long period –

- “Purge” the pipeline and reset the system several times.

? Start-up – flame burning – nevertheless, the display blinks and indicates 02?

- ! Flame failure on start-up.
 - Read off the flame signal (parameter 01) – see page 10 (Reading off the flame signal and the parameters).
If the flame signal is lower than the switch-off threshold (parameter 04), this may be attributable to the following causes:

- ! Short-circuit on the flame rod as the result of soot, dirt or moisture on the insulator –

- ! Flame rod not correctly positioned at the flame edge –

- ! Gas/air ratio incorrect –

! Flame not contacting burner ground as the result of excessively high gas or air pressure –

! Burner or IFD not (adequately) grounded –

! Short-circuit or discontinuity on the flame signal cable –

IFD 244:

! Phase (L1) and neutral conductor (N) reversed –
• Connect L1 to terminal 1 and N to terminal 2.

IFD 258:

! The set value for the cut-off sensitivity is too high –

! Soiled UV sensor –
• Remedy fault.

? **Start-up – no ignition spark and no gas supply – the display blinks and indicates 02?**

! Short-circuit on the ignition or valve output –

- Check the wiring.
- Replace fine-wire fuse: 3.15 A, slow-acting, H.

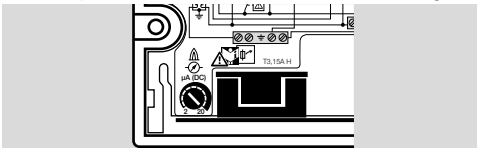

→ The fuse only protects the ignition output! After a short-circuit on the valve output, an internal fuse in the unit trips, which cannot be changed. Return the unit to the manufacturer for inspection.

Checking the safety function

- Close the manual valve.
- Start the automatic burner control unit several times and check that it operates safely.
- If it does not operate correctly, return the automatic burner control unit to the manufacturer.



? **Operation – flame burning – burner interrupted – the display blinks and indicates 04?**

! Flame failure during operation.

- Read off the flame signal (parameter 01) – see page 10 (Reading off the flame signal and the parameters).

If the flame signal is lower than the switch-off threshold (parameter 04), this may be attributable to the following causes:

! Short-circuit on the flame rod as the result of soot, dirt or moisture on the insulator –

! Flame rod not correctly positioned at the flame edge –

! Gas/air ratio incorrect –

! Flame not contacting burner ground as the result of excessively high gas or air pressure –

! Burner or IFD not (adequately) grounded –

! Short-circuit or discontinuity on the flame signal cable –

IFD 258:

! The set value for the cut-off sensitivity is too high –

! Soiled UV sensor –
• Remedy fault.



? **The display blinks and indicates 09?**

! The actuation of the input for the 0 signal (terminal 3) is faulty.

! The 0 signal has been activated too often during the safety time on start-up t_{SA} . The unit start-up was stopped 4 consecutive times during the safety time.

- Remedy cause.

→ 0 signal minimum ON time (terminal 3):

IFD..-3: 8 s

IFD..-5: 10 s

IFD..-10: 15 s

The times must be at least this long, otherwise the automatic burner control unit cannot monitor the burner.

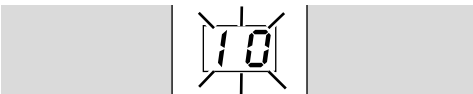

? **The display blinks and indicates 10.**

! Actuation of the remote reset input is faulty.

! Too many remote resets. More than 5 resets have been conducted within the last 15 minutes, either automatically or manually –

! Fault caused by another previous fault which is signalled because the actual cause has not been remedied, for example.

- Pay attention to previous fault messages.
- Remedy cause.

→ The cause will not be remedied by performing a reset every time a fault lock-out occurs.

- Check whether remote reset complies with standards (EN 746 allows resetting only under supervision) and correct if necessary.

→ The IFD may only be reset manually under supervision.

- Press the Reset/Information button on the IFD.



? **The display blinks and indicates 28?**

! An internal device error occurred.

- Remove the IFD and return it to the manufacturer.



? The display blinks and indicates 29?

- ! An internal device error occurred.
 - Reset the unit.



? The display blinks and indicates 31?

- ! Abnormal data change in the factory default parameter settings of the IFD.
 - Establish the cause of the fault to avoid repeat faults.
 - Ensure that the cables have been installed properly – see page 4 (Cable installation).
 - Establish the cause of the fault to avoid repeat faults.



? The display blinks and indicates 32?

- ! Supply voltage too low.
 - Operate the IFD in the specified mains voltage range (mains voltage +10/-15%, 50/60 Hz).
- ! An internal device error occurred.
 - Remove the unit and return it to the manufacturer for inspection.



? The display blinks and indicates 33?

- ! Faulty parameterization.
- ! An internal device error occurred.
 - Remove the unit and return it to the manufacturer for inspection.



? The display blinks and indicates 52?

- ! The IFD is being permanently reset.

IFD 244:

- ! Apply voltage to terminal **6** only for reset, approx. 1 second – see page 4 (Wiring).

IFD 258:

- Apply voltage to terminal **4** only for reset, approx. 1 second – see page 4 (Wiring).



? The display blinks and indicates 53?

- ! A start-up has been initiated during the cycle lock.
 - Adjust the timing cycle to the safety time on start-up and to the ignition device.

t _{SA} [s]	t _Z [s]	Type of ignition	Cycle lock [s]
3	1.8	TZI	10
5	3	TZI	12
10	6	TZI	15
3	1.8	IFD..I	36
5	3	IFD..I	60
10	6	IFD..I	120



? The display blinks and indicates 83?

- ! The UV sensor connections for ionization and N are confused; the UV sensor is signalling a negative flame signal.
 - Check the UV sensor connections and undo the pole reversal.



? The display blinks and indicates 93?

- ! The potentiometer for setting the cut-off point is defective.
 - Change the cut-off point setting on the potentiometer for checking.
 - If the measure described above does not help, the unit has probably suffered a hardware defect – remove the unit and return it to the manufacturer for inspection.



? The display blinks and indicates 81–99?

- ! System fault – the IFD has performed a safety shut-down. The cause may be a unit defect or abnormal EMC influence.
 - Ensure that the ignition cable has been installed properly – see page 4 (Cable installation).
 - Ensure that the EMC regulations for the system are satisfied – particularly for systems with

frequency converters – see page 4 (Cable installation).

- Reset the unit.
- Check mains voltage and frequency.
- If the measures described above do not help, the unit has probably suffered a hardware defect – remove the unit and return it to the manufacturer for inspection.



? The display is permanently lit and shows a dash at the top right.

! The IFD 2xx has detected a fault during internal tests and performed a safety shut-down.

→ The fault may have been caused by external interference during use.

- Ensure that the ignition cable has been installed properly – see page 4 (Cable installation).
- Check the connection between burner ground (PE) and automatic burner control unit.
- Adjust ignition gap on burner to max. 2 mm.
- Interruptions to the power supply are to be avoided as far as possible.
- Ensure that the entire system complies with the requirements of the EMC Directive.
- Press the Reset/Information button and the On/Off button together for at least 5 s.
- If these measures do not help, remove the unit and return it to the manufacturer for inspection.

? IFD does not start even though all faults have been remedied and the IFD has been reset?

- Remove the unit and return it to the manufacturer for inspection.

READING OFF THE FLAME SIGNAL AND THE PARAMETERS

- Press the Reset/Information button for 2 s. The display changes to parameter 01.
- Release the Reset/Information button. The display stops at this parameter and indicates the related value.
- Press the Reset/Information button again for 1 s. The display changes to the next parameter. All parameters can be recalled one after the other in this way.

→ If the button is pressed only briefly, the display indicates what parameter is currently being displayed.

→ The normal program status is displayed again approx. 60 seconds after the last time the button is pressed.

Parameter list

01	Flame signal (0-25 µA)
04	Burner switch-off threshold (2-20 µA)
12	Burner restart: 0 = Immediate fault lock-out 1 = Restart
14	Safety time during operation for gas valve (1; 2 s)
22	Burner safety time on start-up (3; 5; 10 s)
81	Last fault
82	Second to last occurring fault
83	Third to last occurring fault
84	Fourth to last occurring fault
...	...
90	Tenth to last occurring fault

TECHNICAL DATA

Ambient conditions

Condensation and dew in and on the unit are not permitted.

Avoid direct sunlight or radiation from red-hot surfaces on the unit.

Avoid corrosive influences, e.g. salty ambient air or SO₂.

Ambient temperature:

-20 to +60°C (-4 to +140°F).

Storage temperature:

-20 to +60°C (-4 to +140°F).

Transport temperature = ambient temperature.

Humidity: no condensation permitted.

Enclosure: IP 54 pursuant to IEC 529.

Overvoltage category III pursuant to EN 60730.

Permitted operating altitude: < 2000 m AMSL.

Mechanical data

Valve connections: 1.

Max. number of operating cycles:

reset button: 1000,

mains button: 1000,

signalling contacts: 250,000.

Length of sensor cable: max. 75 m.

Length of ignition cable:

IFD: max. 5 m, recommended < 1 m (with TZI/TGI),

IFD.!: max. 1 m, recommended < 0.7 m.

Cable gland: M16.

Installation position as required.

Weight:

IFD: 610 g,

IFD.!: 770 g.

Electrical data

Power consumption:

IFD 258: approx. 9 VA,

IFD 258.!: approx. 9 VA + 25 VA during ignition.

Output voltage for valves and ignition transformer = mains voltage.

Contact rating:

Ignition output: max. 2 A, cos φ = 0.2,

valve output: max. 1 A, cos φ = 1,

signalling contacts: max. 2 A, 253 V AC,
total current for the simultaneous activation of the
valve outputs (terminals 11 and 12) and of the igni-
tion transformer (terminal 10): max. 2.5 A.

Flame control:

sensor voltage: approx. 230 V AC,

sensor current: > 2 μ A,

max. ionization sensor current: < 25 μ A.

Permissible UV sensors:

Elster Kromschröder models UVS 1, 5, 6 and 10
for ambient temperatures from -40 to +80°C (-40
to +176°F).

IFD..I: ignition voltage: 22 kVpp,

ignition current: 25 mA,

spark gap: \leq 2 mm.

Fuses in unit:

F1: T 3.15A H 250 V pursuant to IEC 127-2/5,
replaceable;

F2: 2AT to protect the valve outputs, not replace-
able.

Safety time on start-up t_{SA} : 3, 5 or 10 s.

Safety time during operation t_{SB} : < 1 s, < 2 s.

Ignition time t_Z : approx. 2, 3 or 6 s.

IFD 244

Mains voltage for grounded and ungrounded mains:

120 V AC, -15/+10%, 50/60 Hz,

230 V AC, -15/+10%, 50/60 Hz,

100 V AC, -15/+10%, 50/60 Hz.

Signal inputs:

	120 V AC	230 V AC
Signal "1"	80–132 V	160–253 V
Signal "0"	0–20 V	0–40 V
Frequency	50/60 Hz	

Input current of signal inputs: signal "1": typ. 2 mA.

IFD 258

Mains voltage for grounded and ungrounded mains:

100 V AC, -15/+10%, 50/60 Hz,

120 V AC, -15/+10%, 50/60 Hz,

200 V AC, -15/+10%, 50/60 Hz,

230 V AC, -15/+10%, 50/60 Hz.

Signal inputs:

	120 V AC	230 V AC
Signal "1"	80–132 V	160–253 V
Signal "0"	0–20 V	0–40 V
Frequency	50/60 Hz	

Input current of signal inputs: signal "1" = typ. 2 mA
(reset),
< 2.5 mA (terminal 3).

Designed lifetime

This information on the designed lifetime is based on
using the product in accordance with these operat-
ing instructions. Once the designed lifetime has been
reached, safety-relevant products must be replaced.
Designed lifetime (based on date of manufacture) for
IFD 244, IFD 258: 10 years.

LOGISTICS

Transport

Protect the unit from external forces (blows, shocks,
vibration).

Transport temperature: see page 10 (Technical data).
Transport is subject to the ambient conditions de-
scribed.

Report any transport damage on the unit or packaging
without delay.

Check that the delivery is complete.

Storage

Storage temperature: see page 10 (Technical data).
Storage is subject to the ambient conditions described.
Storage time: 6 months in the original packaging before
using for the first time. If stored for longer than this, the
overall service life will be reduced by the corresponding
amount of extra storage time.

Packaging

The packaging material is to be disposed of in accord-
ance with local regulations.

Disposal

Components are to be disposed of separately in ac-
cordance with local regulations.

CERTIFICATION

Declaration of conformity



We, the manufacturer, hereby declare that the products
IFD 244/258 comply with the requirements of the listed
Directives and Standards.

Directives:

- 2014/30/EU – EMC
- 2014/35/EU – LVD

Regulation:

- (EU) 2016/426 – GAR

Standards:

- EN 298

The relevant product corresponds to the tested type
sample.

The production is subject to the surveillance proce-
dure pursuant to Regulation (EU) 2016/426 Annex III
paragraph 3.

Elster GmbH

Scan of the Declaration of conformity (D, GB) – see
www.docuthek.com

CSA approved



Canadian Standards Association Class: 3335-01
and 3335-81 "Systems (Gas)-Automatic Ignition and
Components"

FM approved



Factory Mutual Research Class: 7611 “Combustion Safeguards and Flame Sensing Systems”.

Designed for applications pursuant to NFPA 85 and NFPA 86.

Eurasian Customs Union



The products IFD 244, IFD 258 meet the technical specifications of the Eurasian Customs Union.

Directive on the restriction of the use of hazardous substances (RoHS) in China

Scan of the Disclosure Table China RoHS2 – see certificates at www.docuthek.com

FOR MORE INFORMATION

The Honeywell Thermal Solutions family of products includes Honeywell Combustion Safety, Eclipse, Exothermics, Hauck, Kromschroder and Maxon. To learn more about our products, visit ThermalSolutions.honeywell.com or contact your Honeywell Sales Engineer.

Elster GmbH
Strotheweg 1, D-49504 Lotte
T +49 541 1214-0
hts.lotte@honeywell.com
www.kromschroeder.com

Global centralized service deployment coordination:
T +49 541 1214-365 or -555
hts.service.germany@honeywell.com

Translation from the German
© 2019 Elster GmbH

Honeywell
kromschroder